

Tools required:

- Ratchet
- 19mm socket (or spanner)
- 13mm socket
- 10mm tube socket
- 10mm spanner
- 6mm hex (for seat bolts)

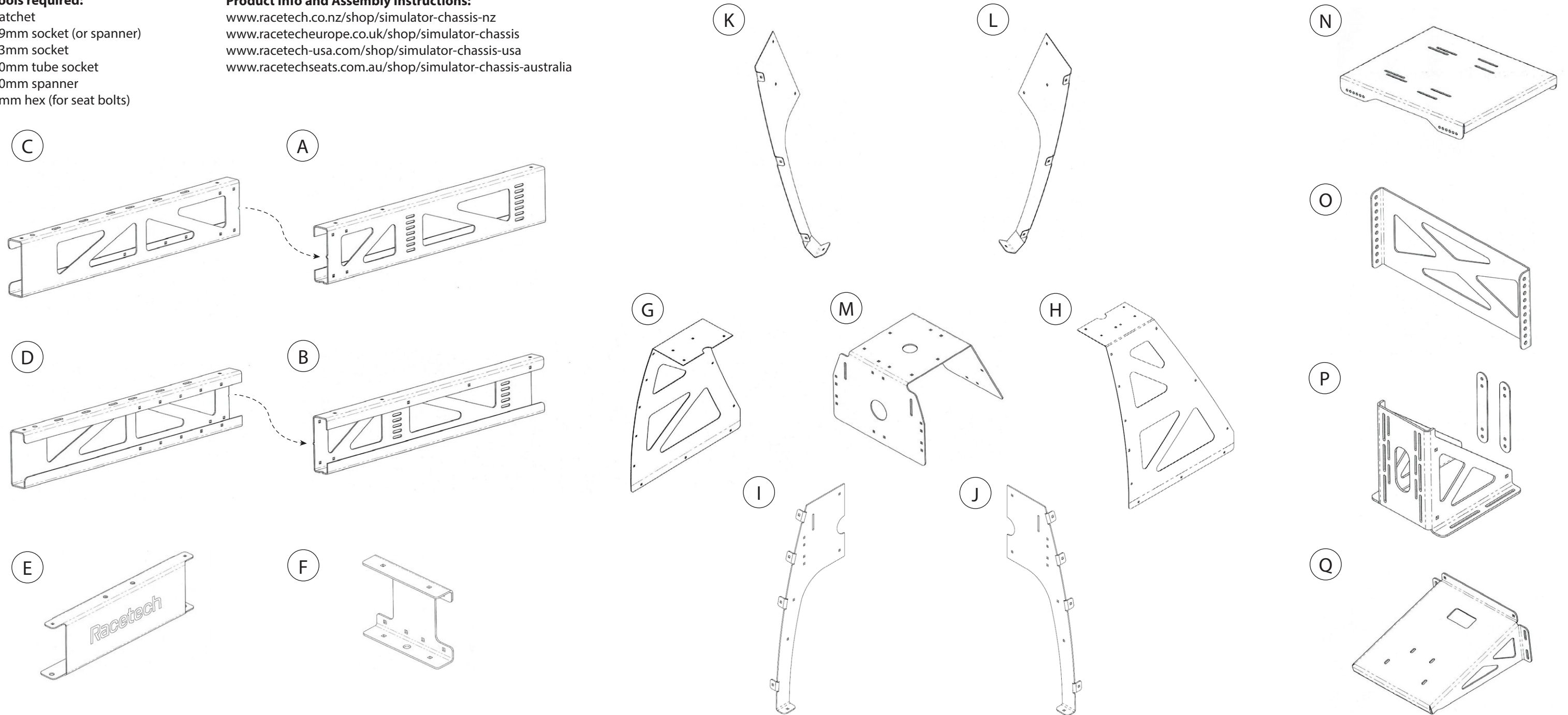









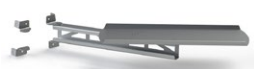



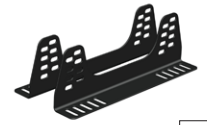

Product Info and Assembly Instructions:

- www.racetech.co.nz/shop/simulator-chassis-nz
- www.racetecheurope.co.uk/shop/simulator-chassis
- www.racetech-usa.com/shop/simulator-chassis-usa
- www.racetechseats.com.au/shop/simulator-chassis-australia



QTY	PART	DESCRIPTION	QTY	PART	DESCRIPTION
1	A	Front chassis rail LH	1	N	Pedalbox mounting plate
1	B	Front chassis rail RH	1	O	Pedalbox adjuster plate
1	C	Rear chassis rail LH	1	P	Monitor mounting bracket
1	D	Rear chassis rail RH	1	Q	Steering mounting bracket
2	E	Chassis end cap			
2	F	Rail Flitch plate	6		Adjuster feet & nuts
1	G	Pod Side LH	94		M6x20 cup heads
1	H	Pod Side RH	100		M6 flange nuts
1	I	Pod Rear LH	2		M8 flat washers (foot plate)
1	J	Pod Rear RH	6		Cable tie clips
1	K	Pod Front LH	8		M6 bolts & washers
1	L	Pod Front RH	4		M8 bolts, washers & nuts
1	M	Pod Internal Doubler			

OPTIONAL ACCESSORIES

 <input type="checkbox"/>	 <input type="checkbox"/>	 <input type="checkbox"/>	 <input type="checkbox"/>	 <input type="checkbox"/>	 <input type="checkbox"/>	 <input type="checkbox"/>	 <input type="checkbox"/>
 <input type="checkbox"/>	 <input type="checkbox"/>	 <input type="checkbox"/>	 <input type="checkbox"/>	 <input type="checkbox"/>	 <input type="checkbox"/>	 <input type="checkbox"/>	 <input type="checkbox"/>